

THE LEONARDO'S PROJECT FOR THE *TIBURIO* OF MILANO CATHEDRAL: SOME CONSIDERATION ON STATIC BEHAVIOUR

Pier Paolo Diotallevi*

* University of Bologna – Bologna, Italy.

Abstract

Among the numerous intuitions and projects that have characterized Leonardo da Vinci's art and technique, the conception of architectural structures has an important role, including studies and the proposal for the project of the *tiburio* of the Milan Cathedral. Based on some hypotheses of reconstruction of geometries and structural systems developed in the architectural field, and formulated as an interpretation of original drawings, it was intended to test whether the solutions proposed by Leonardo were also actually feasible, examining them with current structural modelling techniques, of evaluation of static functioning and definition of structural safety. Using the finite element method (FEM), two different proposals were investigated for the vaults and supporting arches of the *tiburio*, finding its substantial reliability even though this was hypothesized in the absence of technical verification tools that did not exist at the time.

Keywords

Leonardo da Vinci, Architecture, Vault, Arch, Static, Reliability, FEM

1. Introduction

Leonardo da Vinci's genius led him to try his hand in different fields of art, science and technology. These also include construction engineering and architecture as evidenced by its numerous and often not completely understood writings and drawings. In the field of construction, his way of dealing with different themes was born both from his deep knowledge of nature and from his intuition which, however, did not always lead to practical achievements. Nonetheless, his thought was always directed and oriented towards identifying solutions and new proposals for the various themes sometimes determined and set by himself.

Testimonies of his activity in the field of architecture are the numerous drawings, sketches and models reported, for example, in the *Codex Atlanticus* (CA) which collects a large part of the works of his mind and his intuitions.

Leonardo also took care of studies for the construction of the *tiburio* to be built on a system already present for about a century.

Numerous studies have been carried out on Leonardo's hypothesis in order to capture the essence and ideas that guided him in the design.

This resulted in models for which it was considered interesting to examine whether his intuitions and schemes could be realized and whether the work built according to those indications could be considered statically efficient.

We, therefore, start from the studies and drawings reported by Guillaume and Frommel (Guillaume, 1987), Apollonio, Gaiani, Bertacchi and Frommel (2018) relating to the representation in terms of essential construction elements. These authors proposed two different solutions that interpret Leonardo's drawings contained in sheets 850r and 851r of the CA that will be analysed here.

With these references, we intend to evaluate whether Leonardo's design hypothesis was feasible by remembering that until then, and for a few centuries to follow, the constructive criterion was dictated by the experience and intuition of the architect, as criteria were not yet defined for the evaluation of the static behaviour of buildings.

2. The construction examined

The structural organization of the *tiburio* of the cathedral of Milan proposed by Leonardo is based on an already existing system and he also presents a project whose essential elements are contained

in drawings documented in codes and manuscripts attributed to him.

To understand the criteria guiding him in the design, it is first necessary to define the existing layout consisting of an already stated and constructed array of pillars that mark the organization of the Latin cross plan with the main body with five naves, transept and apse with three naves. The complex shape of the plant also points out the great importance that was intended to be given to this church, making it, in fact, one of the most important and impressive works not only of the period but of the entire history of the great cathedrals.

The plan is shown in Fig. 1 where the parts affected by the insertion of the *tiburio* are enclosed in two areas highlighted in red and blue comprising the vertical structures directly involved in supporting the *tiburio* itself.

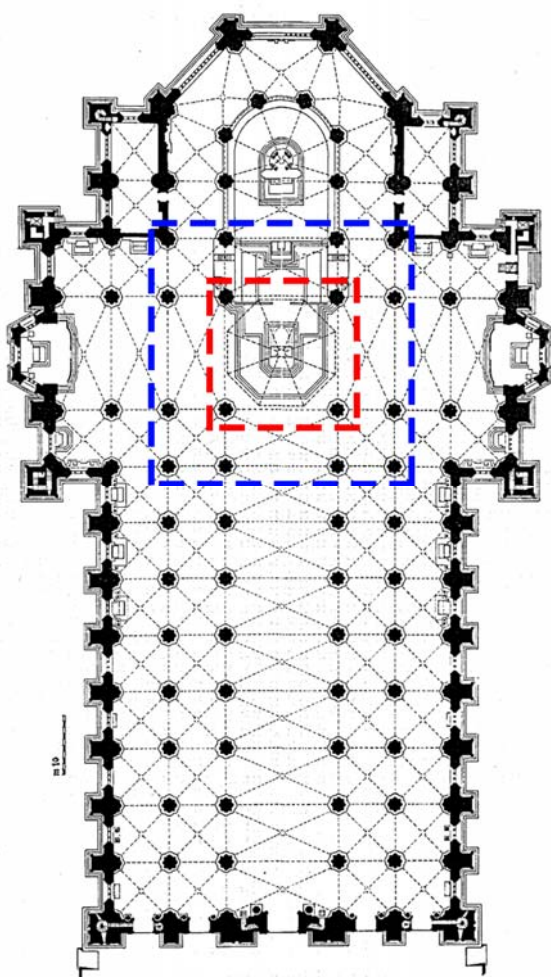

Fig. 1: Plan of Milan Cathedral and the two areas comprising the vertical structures directly involved in supporting the *tiburio*.

The first solution proposed involves only the four large pillars located at the intersection between the central nave of the main body and the central nave of the transept (area enclosed by the red line in Fig. 1 and Fig. 2).

The second, wider-ranging solution also involves the pillars adjacent to those identified in the first solution (area enclosed by the blue line in Fig. 1 and Fig. 2).

The two solutions proposed differ not in the organization of the vaults of the *tiburio*, but in the system of arches that stand out from the existing columns and support, partly countering the horizontal actions, the vaults themselves.

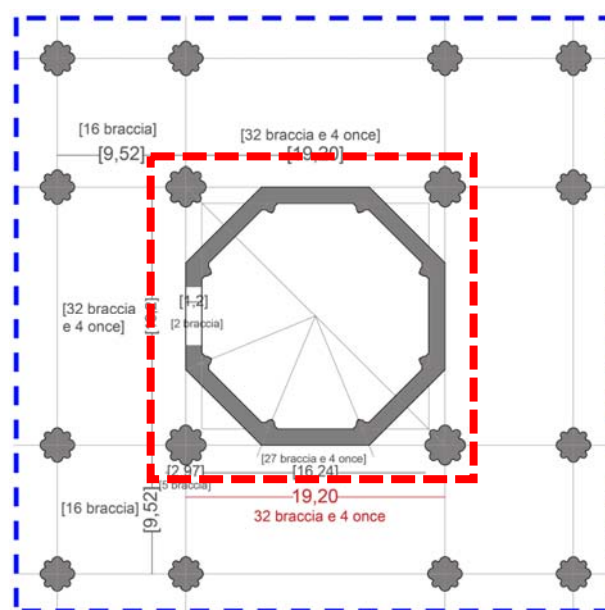

Fig. 2: Detail of the plan of Milan Cathedral, at the intersection between the central nave and the transept, affected by the *tiburio* which indicates the distance between the centre of the columns.

For the investigations that follow, reference was made, as regards the shapes and dimensions, to the diagram identified by Apollonio, Gaiani and Bertacchi reported in Guillame, 1987.

In Fig. 3 (a) reconstruction of the *tiburio* after Leonardo's drawings (f. 851r / 310 vb and f. 850r / 310 rb of the Codex Atlanticus) based on the hypothesis of Guillame and Frommel (Guillame, 1987); in Fig. 3 (b) hypothetical reconstruction proposed by Apollonio, Gaiani, Bertacchi and Frommel (2018): it will be referred to in subsequent evaluations.

Leonardo's drawings are reproduced in Fig. 3c (Manuscript B - 2173, f. 27 r).

In Fig. 3d the structural schemes are reproduced to which the previously mentioned authors have referred for the identification of the structural organization they have identified and proposed.

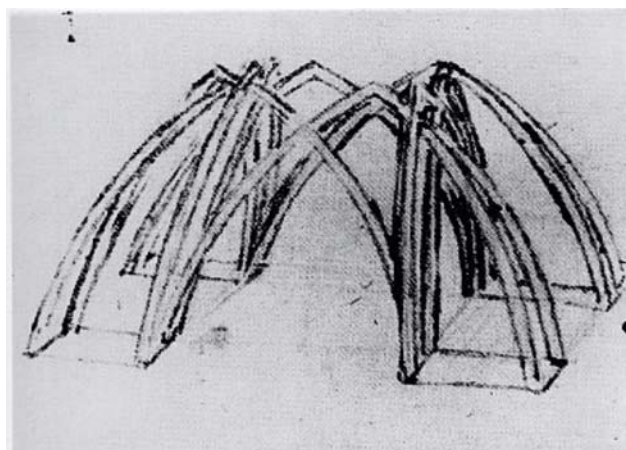
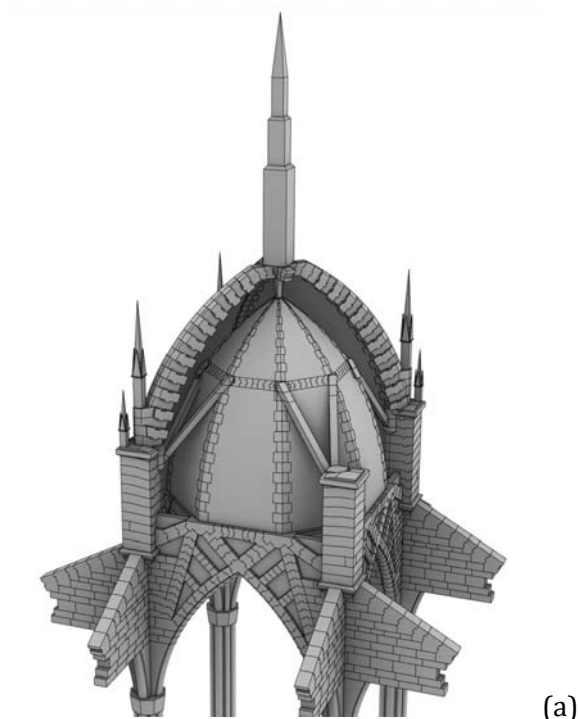

Fig. 3c: Leonardo, Manuscript B - 2173, f. 27 r.

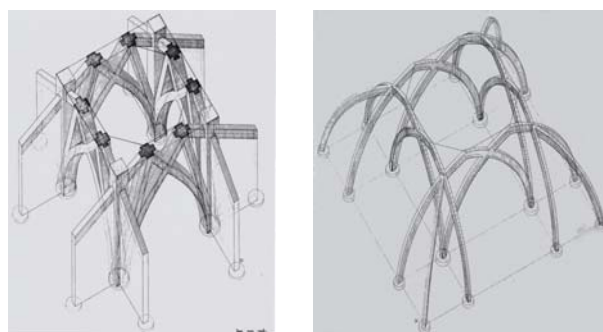

Fig. 3d: Guillaume and Frommel (Guillaume, 1987), some hypothetical reconstruction of structural organization for the base of the *tiburio*.

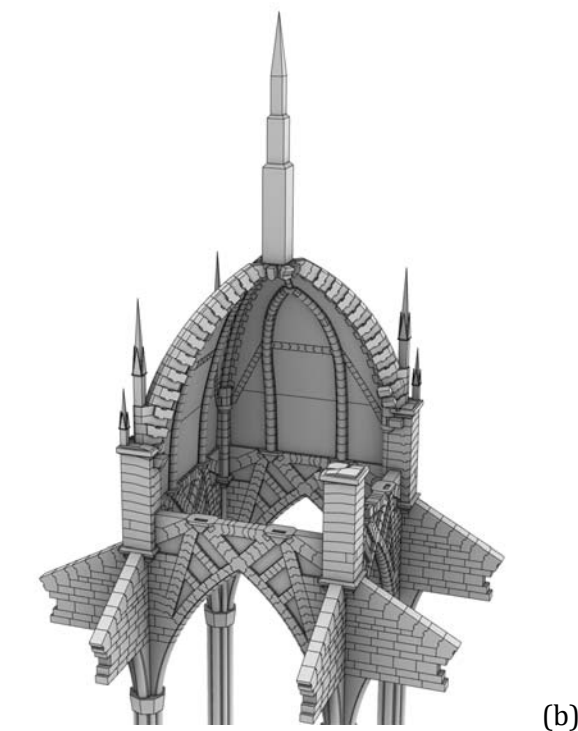

Fig. 3: Hypothetical reconstruction of the *tiburio* of the Milan Cathedral after Leonardo's drawings (Codex Atlanticus f. 851r and f. 850r) (a) by Guillame, Frommel; (b) by Apollonio, Gaiani, Bertacchi, Frommel.

The elevation configuration of the *tiburio* is shown in Fig. 4 which also identifies the essential construction elements.

The pillars have a height of 30.8 m; the arch system supporting the vaults is set on them and has a height of 13.60 m. The internal vault has a height of 19.25 m and the external vault is 22.45 m high. The top of the external vault is located 72 m from the base floor and the insertion of the central pinnacle brings the overall height of the work to 94.20 m.

The construction system is organized starting from the vertices of a square plan with a side of 19.25 m at which they are pillar posts with the cross and lobed sections with a maximum size of 2.90 m they are entrusted with the support of the *tiburio*. On these pillars stands out a system of double-pointed arches, arranged according to each side of the square plan, having the function of preparing the tax of the internal vault proposed with an octagonal plan. It is precisely this

particular construction arrangement, necessary to move from a square plan to an octagonal plan for the internal vault and having kept the square plan for the external vault, to characterize the particularity of the construction system. In this way, in the keystone of these intersecting arches is created a system of eight supports connected by an octagonal ring: it constitutes the first parallel element of the internal vault.

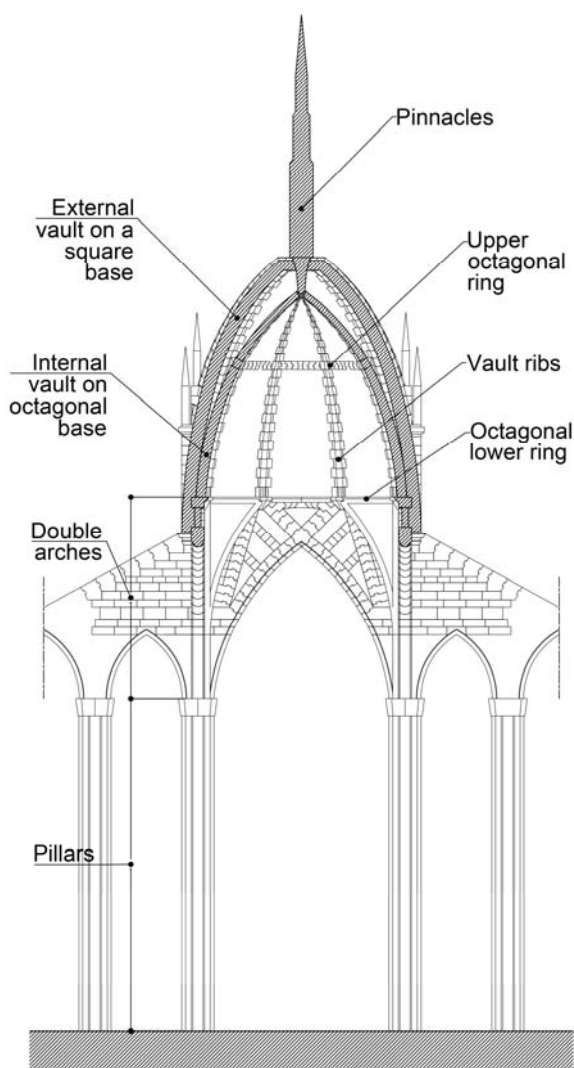

Fig. 4: Essential building elements.

The external vault, on a square plan, is supported by four arches of light equal to the centre distance of the pillars supporting the *tiburio*, alongside the double arches that support the internal vault; these arches have the same shape as the vaults of the main nave and the transept and constitute an independent support system between the external and internal vaults.

The internal octagonal vault stands out from an octagonal ring (called lower octagonal ring) with equal sides. From the vertices depart ribs with a parabolic branch shape and meet, in the centre of the plant, at the top. The individual portions of the vault are woven between the ribs, and therefore have a cylindrical shape with a horizontal generator and a parabolic direction.

At a height equal to about 2/3 of its height, the vault is crowned by another horizontal octagonal ring connected to the top of the pillars by four V-shaped props whose upper ends engage in the vertices of the upper ring and the other ends converge on the vertical axis of the four main supporting pillars. Fig. 5 shows the horizontal sections of the *tiburio* performed at the level of the internal vault shutter and at the level of the upper octagonal ring; it recognizes the arrangement of the elements mentioned.

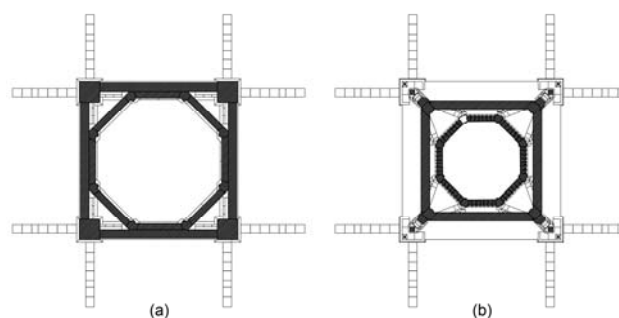

Fig. 5: Horizontal sections of the *tiburio* at the level of the internal vault shutter (a) and at the level of the upper octagonal ring (b).

The external vault, with a square plan, is also provided with four ribs that start from the top of the pillars and converge towards a higher central point with parabolic arch shapes. The four sails between the arches are also cylindrical vault segments with a horizontal generator.

The two vaults are joined at the vertex by a connecting element.

The complex is completed by some pinnacles, the most important of which is placed in the key of the vaults and extends for about 22m; another 8 pinnacles are placed, in pairs, near the external vault shutter, close to the axis of the pillars. These elements, of sure architectural effect, also have the function of carrying vertical loads at points useful for the stability of the system.

The overall height of the work is thus 72 m at the top of the external vault and 94.2 m at the top of the highest pinnacle.

The dimensions of the structural elements that make up the *tiburio* and its supporting elements are shown in Tab. 1.

Tab. 1: The dimensions of the elements defined to be used for structural calculation

TIBURIO STRUCTURAL ELEMENTS DIMENSIONS	Section (BxH m)
PILLARS (medium section)	2,5 x 2,5
<i>OCTAGONAL VAULT</i>	
Octagonal lower ring	1,20 x 1,00
Upper octagonal ring	0,85 x 0,73
Double arches under octagonal vault	1,20 x 1,33
Ribs octagonal vault	1,40 x 1,90
Struts on octagonal vault	0,85 x 0,73
Thick octagonal vault lower part	0,90
Thickness of the octagonal vault at the top	0,75
<i>SQUARE VAULT</i>	
Arch support vault	1,20 x 1,20
Ribs vaulted square	1,30 x 2,00
Thick square vault	1,10
<i>PINNACLES</i>	
Pinnacle top square vault:	
- upper portion	1,54 x 1,54
- intermediate portion	2,21 x 2,21
- lower portion	3,07 x 3,07
Pinnacles near pillars	0,70 x 0,70
<i>CONNECTION IN KEYSTONE</i>	
Connecting element	0,90 x 0,90

Fig. 6 shows the vertical section of the structural complex with reference to the schematic, taken on the basis of the Leonardo's drawings (f. 851r / 310 vb and f. 850r / 310 rb of the Codex Atlanticus). The double vault taken for the construction of the *tiburio* is believed to have only one aesthetic meaning: the perception of the vault seen from the inside and the outside in its overall shape changes radically proposing different perspectives.

The reason for the double vault, therefore, appears to have a very different meaning than proposed and executed by Brunelleschi for the Florence Cathedral (already carried out before Leonardo's birth). Brunelleschi carries out both the external and internal vaults on an octagonal base and the double vault, in that case, assumes the sole purpose of lightening the construction. The

internal vault is thicker than the external vault, which almost only takes on the covering task.

In Leonardo's design, the entire construction was foreseen in natural cut stone for which, in the following models, a specific weight of 2700 kg/m³ was assumed, a reliable value for a more easily worked stone. The individual segments are indicated with a particular shape, not simple prisms but elements with sharp-edged surfaces, as appears in the renderings in Fig. 3, whose usefulness was perhaps related to the greater ease of assembly of the main arches supporting the vaults making thus the temporary shoring useful for assembly and the assembly phases themselves are simpler and less demanding. In the filling parts between the double arches from the drawing, there is the presence of brick masonry which buffers the areas between the extrados of the arches and the internal vault shutter.

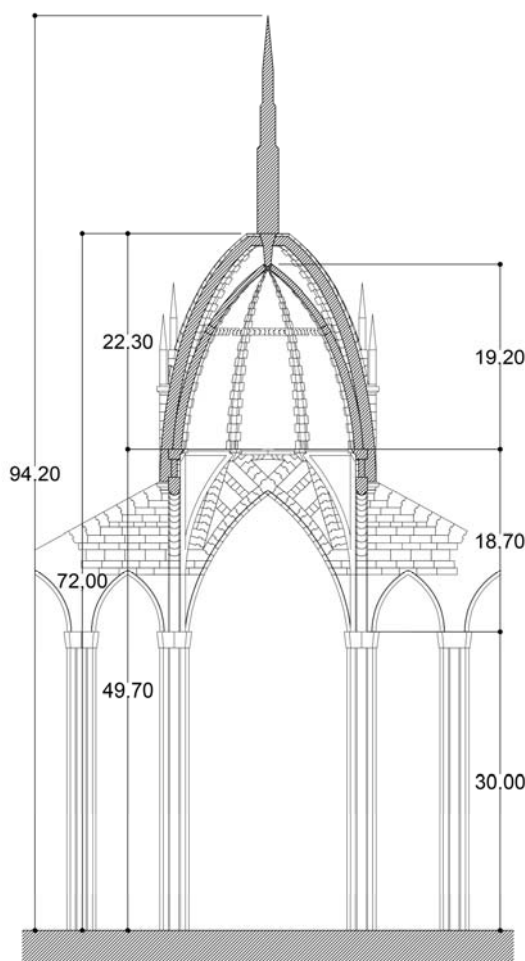

Fig. 6: Vertical section of the structural complex with reference to the schematic, taken on the basis of the Leonardo's drawings.

3. Building modelling

For the investigation on the structural behaviour of the *tiburio*, in the two cases examined, only the structural parts supporting the vaults were taken into consideration, simulating the omitted parts of the aisles that intersect the *tiburio* itself with appropriate release conditions. In particular, it was assumed that the parts not considered represent constraints capable of contrasting only the horizontal actions, as in fact happens, consequent to the presence of vaults and arches proper to the portion of the structure investigated. Fig. 7 highlights the positions in which these constraints have been introduced.

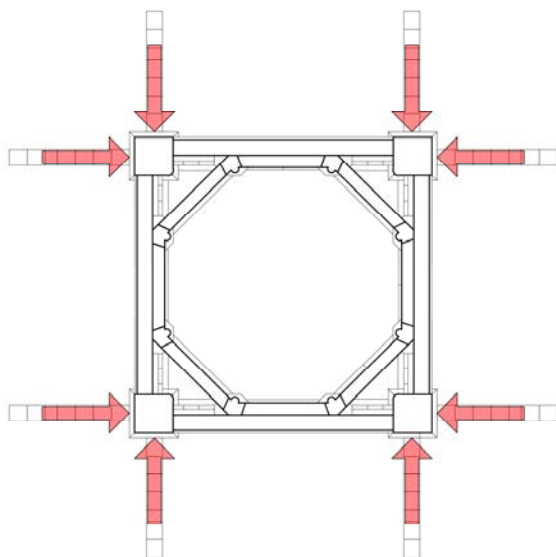

Fig. 7: The positions of constraints introduced to bear the horizontal actions.

The finite element method (FEM) is a numerical technique capable of providing approximate solutions to problems described by partial differential equations, reducing the latter to a system of algebraic equations. It is a method widely used today in the study of structural engineering problems. It is applied by discretizing the continuous material body into discrete elements whose behaviour, static or dynamic, is described as a function of the movements of the nodes that make up its edge and assigning the functions that represent its behaviour within it. The more discretized the discretization (finite element mesh), the greater the precision of the state of tension and deformation of the considered structure. The method leads to the writing of systems of large equations whose management

and solution is possible through dedicated software for this purpose.

For the modelling (Milani & Lourenço, 2007; Girardi, Padovani, Pellegrini, Porcelli, & Robol, 2020), reference was made to a structural computational program using beam-like finite elements for arches and pillars, while the vaults were modelled with shell-style two-dimensional finite elements capable of representing both the membrane and the plate regime (Gaetani, Monti, Lourenço, & Marcari, 2016; Bertolesi, Adam, Rinaudo, & Calderón, 2019). The dimensions of the individual parts are shown in Tab. 1.

3.1 Modelling the first constructive hypothesis

To better understand the organization of the elements that schematise the structural behaviour in Fig. 8a, 8b, 8c, the succession of the construction elements is shown, highlighting, for now, the parts relating to the internal vault only. Fig. 8d shows the connection structure between the square plan and the octagonal plan. Fig. 9a and 9b respectively show the ribs of the external vault with the supporting arches of the same and the overall view of the external vault with the presence also of the pinnacles placed at different heights.

Fig. 10 shows the set of the structural model represented both in solid form and, in transparency, the finished element mesh scheme.

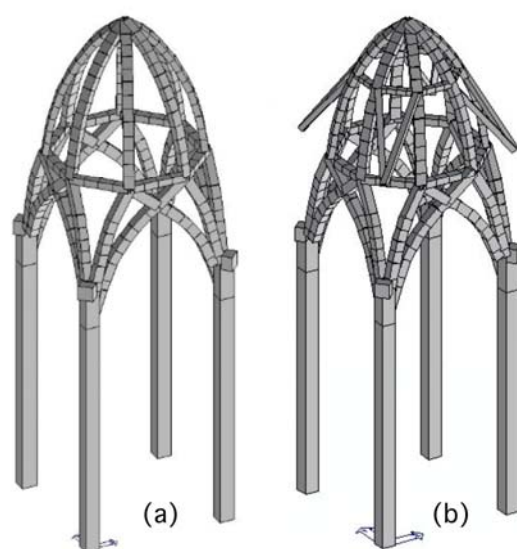

Fig. 8: (a) Octagonal lower ring, Ribs octagonal vault, Double arches under octagonal vault; (b) Upper octagonal ring, Struts on octagonal vault.

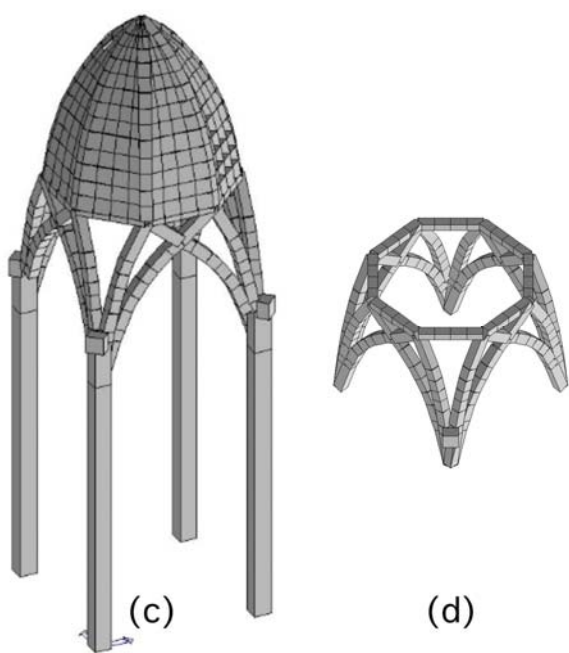

Fig. 8: (c) Octagonal vault; (d) the connection structure between the square plan and the octagonal plan.

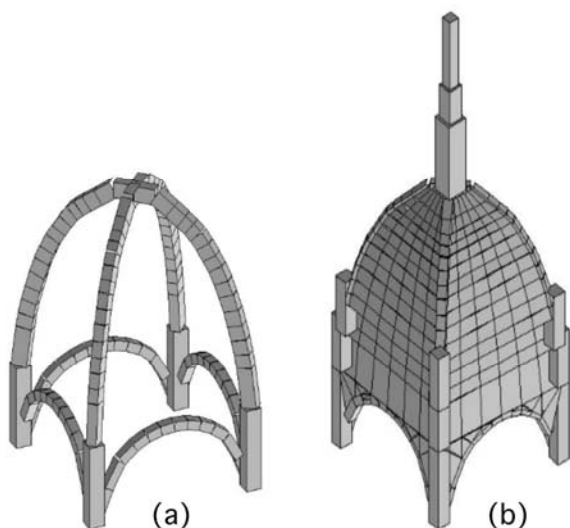

Fig. 9: (a) Ribs of the external vault with the supporting arches; (b) square external vault.

The actions to which the structure was subjected are only those due to its weight. It represents almost all the loads acting; in general for stone constructions the effect of other actions, for example, the action of the wind or the action of the snow, often make irrelevant contributions compared to those produced by the weight alone, since this is at least an order of magnitude greater than effects of natural phenomena and therefore it

is legitimate to neglect the aforementioned contributions.

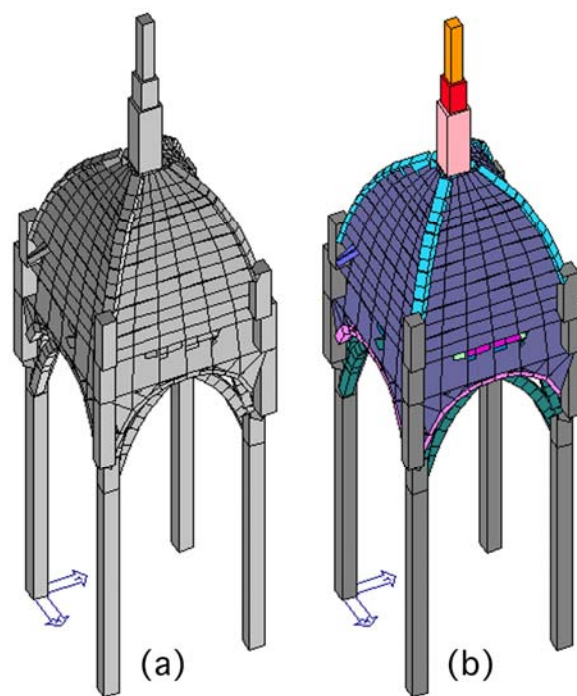

Fig. 10: (a) The set of the structural model represented both in solid form and (b) in transparency.

The investigation of the structural behaviour of the *tiburio* was carried out with reference to an elastic and linear behaviour of the elements having load-bearing functions. The loads involved are, as already mentioned, the only proper weights, therefore, those loads that insist on the structure for its entire life-cycle. This circumstance requires us to know the extent of those effects that will always be present and therefore perfectly suitable for carrying out considerations on the reliability of the construction.

As a first approximation, the basic parameters, recurring for the buildings in worked stone, have been assumed as follows:

- Specific weight $\gamma = 2,700 \text{ kg/cm}^3$
- Modulus of elasticity $E = 30.000 \text{ kg/cm}^2$
- Poisson's ratio $\nu = 0.12$
- Breaking strength $\sigma_r = 300 \text{ kg/cm}^2$.

3.2 The tensional states of the first constructive hypothesis

The tension states of the vaults and arches were assessed using the finite element method.

For the vaults, reference was made to the tension states resulting from the membrane regime: the tensions in the direction of the meridians and parallels are significant. The principal stresses are useful for determining the maximum values of the normal compressive and traction stresses, for location of any cracks and also to legitimate the hypothesis of elastic and linear behaviour for a material that does not resist traction.

Fig. 11 shows, in a single representation, the states of tension in the meridians (segments circled in red) and in the parallels (segments circled in blue); it is clear that the maximum tensional states of compression (negative in the legend) are in the order of 20 kg/cm², while the average values are between 2 and 10 kg/cm². However, there are also tensile stress states in the parallels close to the tax that do not exceed 6 kg/cm².

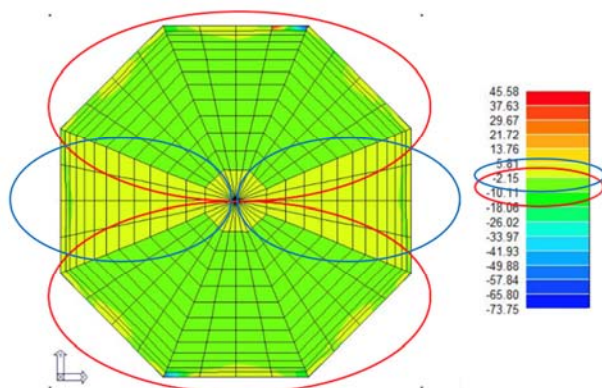

Fig. 11: The states of tension in the meridians (segments circled in red) and in the parallels (segments circled in blue).

The combination of these values indicates the good functionality of the portions of the internal vault. Higher tension peaks may be present, in very limited areas of the springing plane, which, however, do not represent a significant evidence of static concern.

Other elements of the internal vault are the eight arches placed at the intersection of the vaulted segments. For them, the pressure-flexion regime was examined, noting how the flexural regime is of such an extent as to not produce tractions.

Fig. 12 shows, with colour maps, the normal stress regime and the tensional states of an arch; these values are repeated for all the arches that

make up the ribs of the internal vault due to the symmetry of the elements of the construction system.

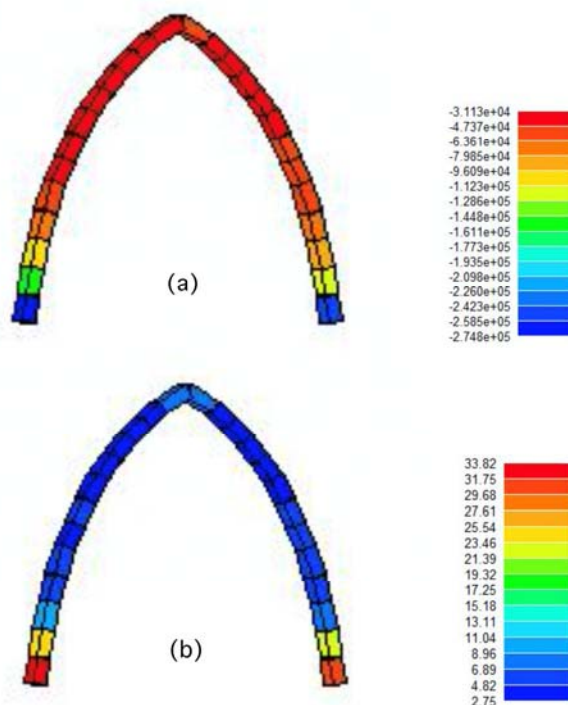

Fig. 12: (a) Normal effort on the arches of the internal vault (in kg) and (b) Maximum stresses due to pressure bending of the arches of the internal vault (in kg / cm² and positive if compression).

The tensional states of these arches, dominated by normal stress, always remain compression with maximum values of the order of 30 kg/cm², a high value, but still admissible for the type of stone expected for construction.

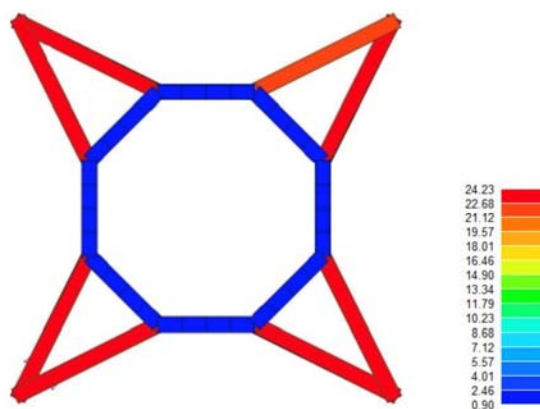

Fig. 13: Upper octagonal ring and struts.

Some difficulties arise in the interpretation of the function of the elements indicated as "upper octagonal ring" and "V-shaped props". For them, a significant structural function is not recognized, confirmed also by the limited tensional states (Fig. 13) to which these elements are subjected. The limited states of tension found on the vault make the upper octagonal ring system and its props inessential. However, it appears that the tensional state of these elements is compatible with the good functioning of the vault, given the values of the stresses identified.

In Fig. 14a and 14b are represented the values of normal stress and tensions for the double arches placed in support of the internal vault.

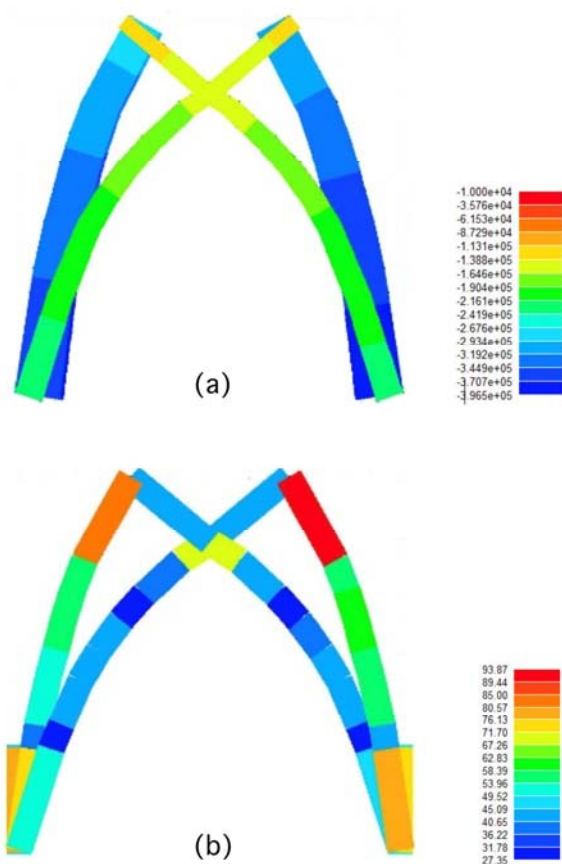

Fig. 14: (a) Normal effort (kg) and (b) Normal stresses for pressure bending (kg/cm²).

Some local situations show high tension states; these values are very attenuated, and therefore compatible with the resistant capacity of the stone if two circumstances are considered.

The first concerns the area between the two arches. As shown in Fig. 3, this area is buffered

with masonry thus establishing a behaviour that is no longer a simple arch, but a membrane with almost total cancellation of the flexural regime. The second consideration relates to the presence of masonry pendentives arranged according to the scheme of Fig. 15.

The transition from a modality of behaviour from slender elements to two-dimensional bodies loaded in their middle plane produces significant increases in the rigidity of the resistant system at the same time as a strong reduction in the tensional state which can, therefore, fall within values deemed bearable of the new resistant structure.

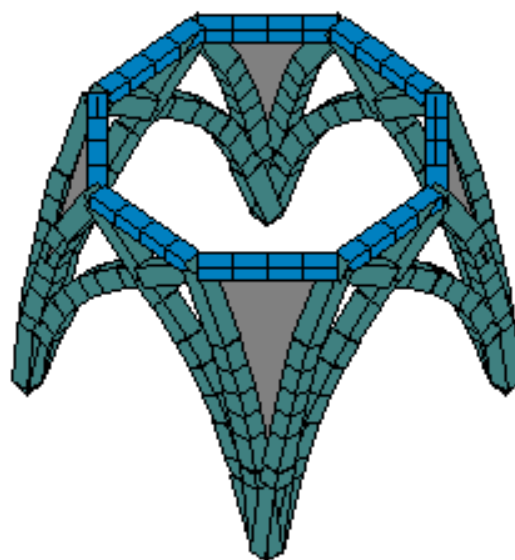

Fig. 15: The masonry pendentives arranged between arches.

3.3 Checking the tension conditions of the internal vault

To be able to express a judgment based on the reliability of the stress states evaluated with the finite element method, it was deemed necessary to carry out also simplified analyses of this state conducted with seventeen alternative methodologies for an appropriate comparison.

For this purpose it has been hypothesized to schematize the internal vault placed on an octagonal base with a revolving surface whose generator was of the same type as the single sails on an octagonal shape base; for this dome of revolution, a rib thickness of 80 cm was assumed and reference was made to the determination of

the membrane regime due to its weight only, support on a conical seat was assumed.

The circular plan of the simplified scheme (Fig. 16) has been defined with a radius of average value between that of the inscribed circumference and circumscribed circumference to the octagonal plan.

Fig. 17 shows the scheme of the surface of revolution and the regime of the membrane forces in which N_1 represents the neo meridian effort and N_2 the effort in the parallels. Since the surface has radial symmetry due to the effect of its own weight only, the tangential actions N_{12} are null.

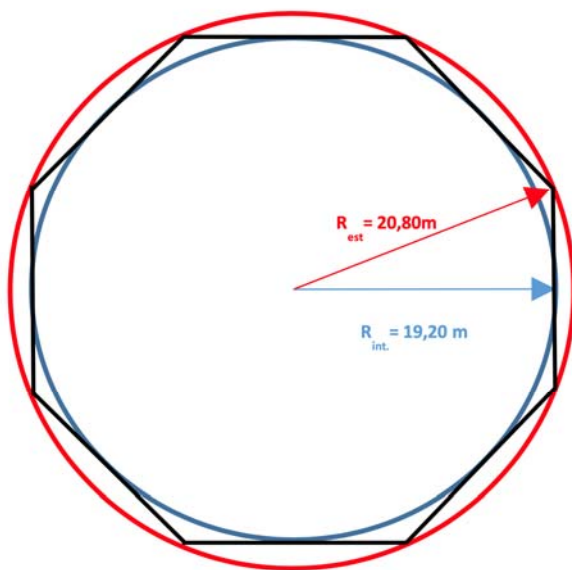

Fig. 16: The circular plan of the simplified scheme defined according to a radius of average value between that of the inscribed circumference and circumscribed circumference to the octagonal plan.

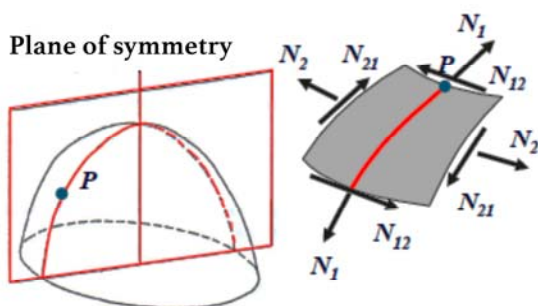

Fig. 17: Diagram of the membrane regime.

The diagram in Fig. 18 shows the summary of the processing relating to the estimate of the state of tensions in the dome.

It is clear that the maximum compression tension value in the meridians is of the order of 4 kg/cm², an absolutely acceptable value and comparable with that obtained by processing using finished elements (see Fig. 3).

This circumstance confirms the reliability of the tension states assessed with independent procedures and the actual possibility of construction and good structural behaviour of the vault designed by Leonardo.

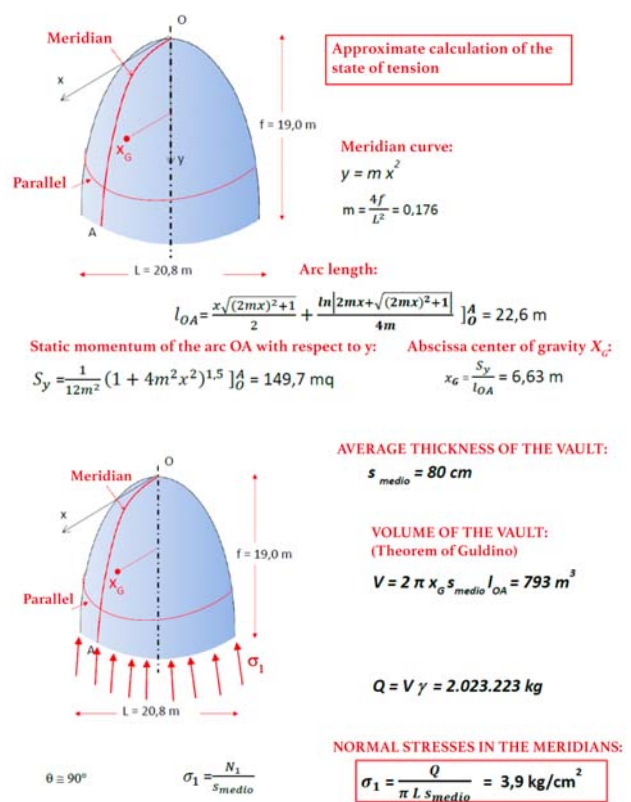

Fig. 18: The summary of the processing relating to the estimate of the state of tensions in the dome.

3.4 Verification of the tensional conditions of the external vault

With a procedure similar to the one above, the external vault and the relative supporting arches were also modelled with finished elements.

As a synthesis of these elaborations, the trends of tensional conditions due to the effect of their weight deduced from the overall behaviour of arches and vaults according to the model of Fig. 10 are reported.

3.5 The vault and the external arches

Fig. 19 shows the main maximum and minimum tensions on the sails of the external vault. The maximum values of the compressions, always limited to very narrow areas of the vault and in particular in the areas of connection with the underlying pillars, are less than 30 kg/cm², while those of traction, which can generate cracks are very limited and do not exceed 2 kg/cm² in the lower band of the elements of the single sails. These are very low values, non-prejudicial of the overall strength of the construction.

Although in masonry, in general, the tensile strength of the material is neglected (i.e. the poor resisting capacity of the mortars connecting the elements that make it up), however, it is possible to admit a tensile strength of the masonry which in the present recurring scheme can be compared to shear strength in the absence of normal effort.

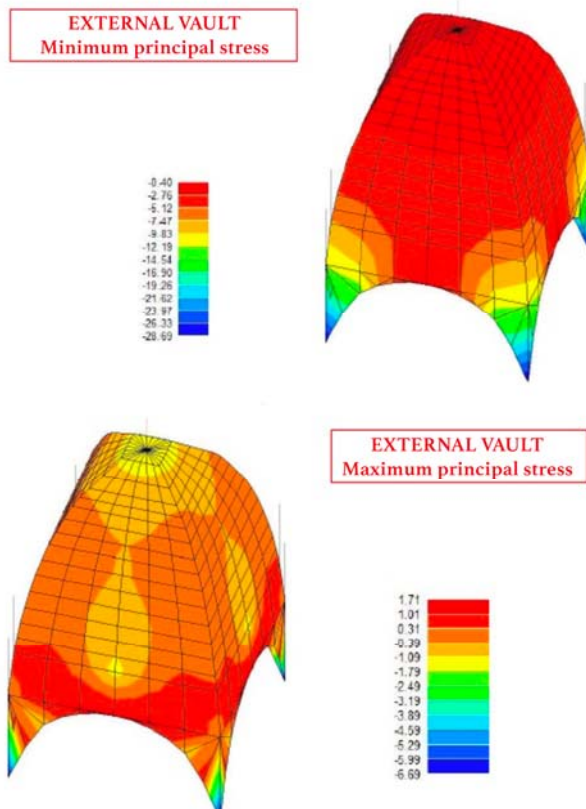

Fig. 19: External vault stress states.

The ribs of the external vault (see Fig. 9a and 9b) are subjected to tensional states whose values are summarized in Fig. 20a and 20b.

The ribs placed in correspondence of the diagonal of the tax square of the external vault

including the appendices of the pinnacles are represented.

Also for these arches, it is therefore conceivable an adequate structural behaviour due to the limited tensional states of the same.

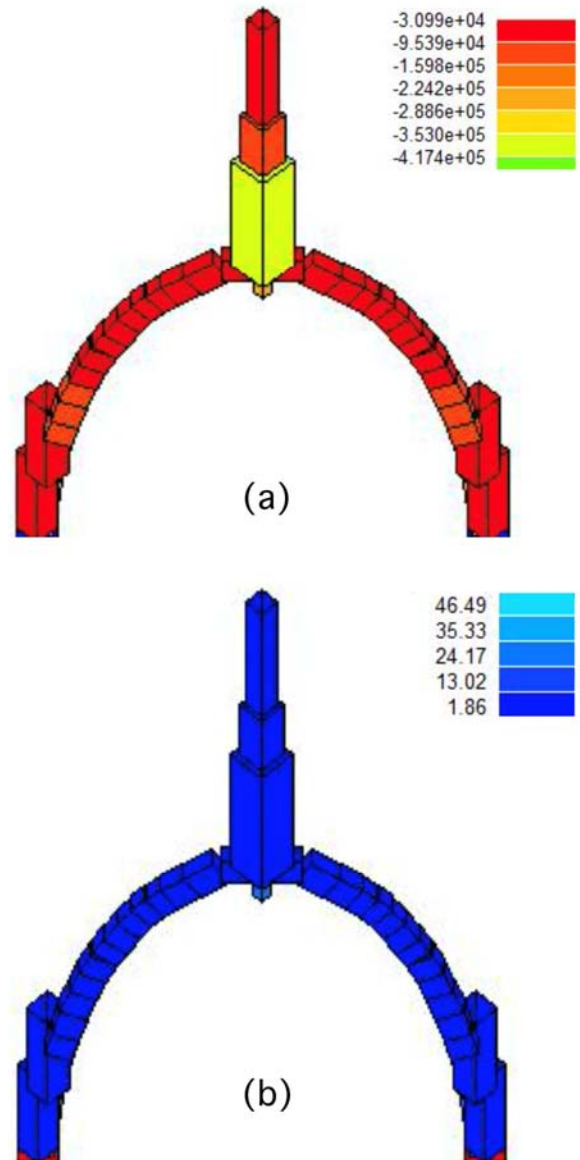

Fig. 20: (a) Normal effort of the ribs of the external vault (negative the normal compression efforts expressed in kg) and (b) Normal tension of the ribs of the external vault (positive compression tensions expressed in kg/cm²).

4. The modelling of the second constructive hypothesis

An alternative to the support system of the vaults with a different configuration of the arches is represented in Fig. 21 according to the proposal

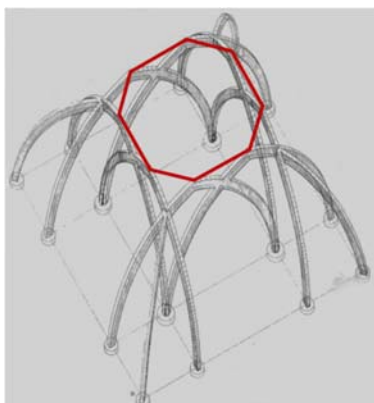

Fig. 21: Alternative of support system concerning the second constructive hypothesis (Guillaume 1987).

reported in (Guillaume, 1987). In this case, as already mentioned, the arch system also involves the first spans adjacent to the *tiburio* area of the central nave, the transept and the apse. Thus, extends the support system of the *tiburio* with the creation of even wider arches and unusual configuration.

Fig. 22 shows the scheme of the *tiburio* with vaults and supporting arches and the same with only the linear elements highlighted.

The vaults (internal and external) are not affected by the different arrangement of the system that supports them as the support areas of the sails and stiffening ribs remain identical.

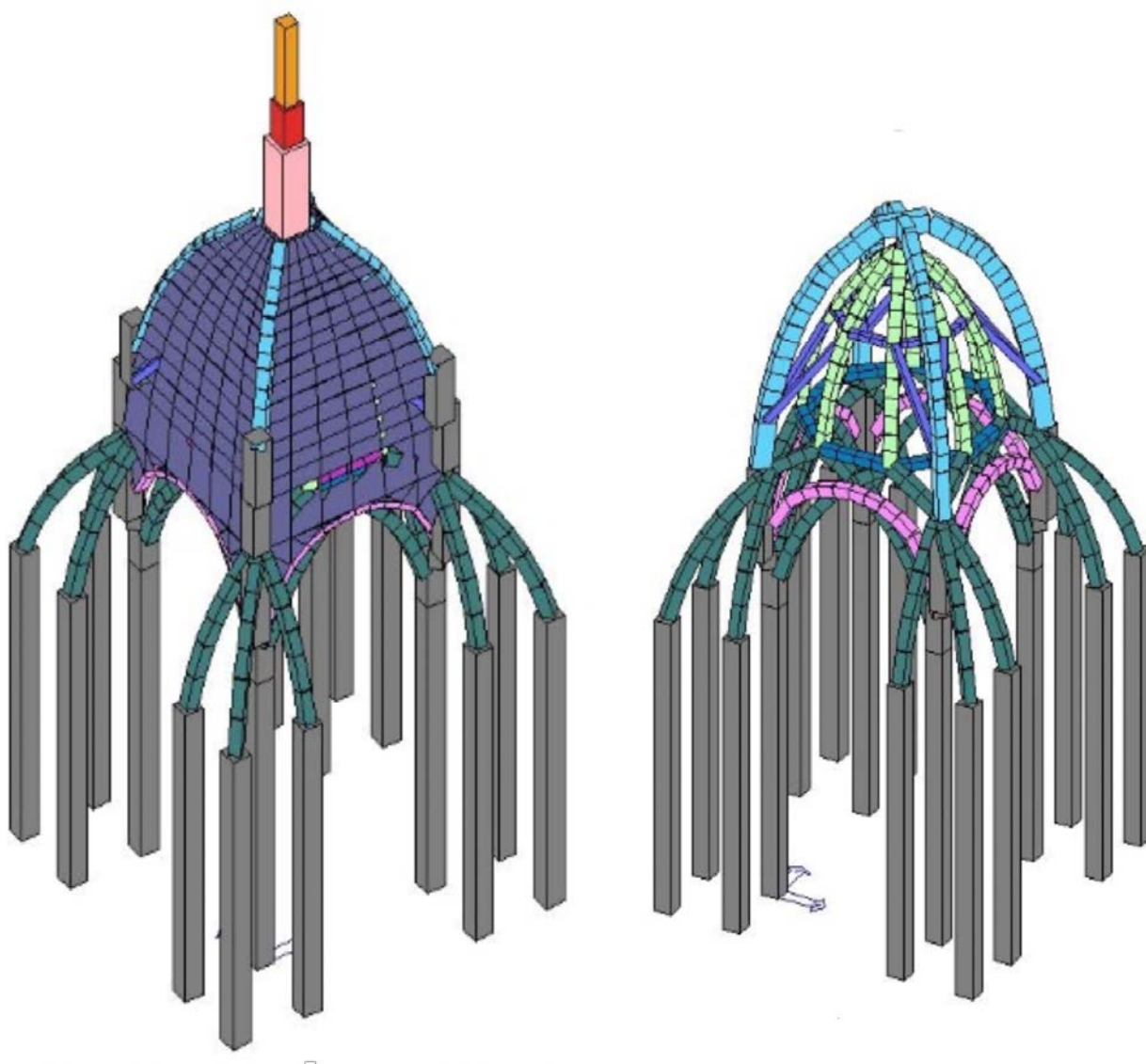

Fig. 22: Scheme of the *tiburio* with concave surfaces and without, concerning the second constructive hypothesis (Guillaume 1987)

The normal effort in the arches included within the plant of the *tiburio* does not differ substantially from the value obtained in the first model.

The twelve semi-arches external to the plant of the *tiburio*, as shown in Fig. 23, are subject to a reduced normal effort compared to the corresponding elements (eight elements) present in the first solution and therefore the reduction of the relative stresses which may appear anomalous is justified. In this second configuration, however, the flexural regime of the arches assumes importance and the values of the tensions increase, making this solution less reliable than the one previously studied.

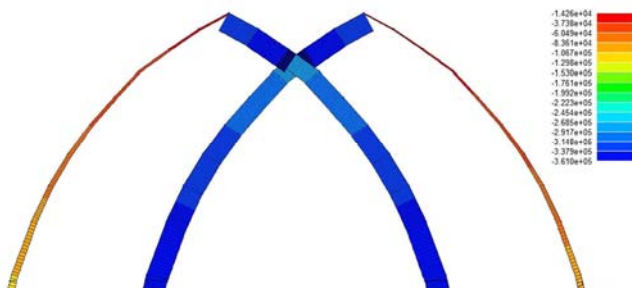

Fig. 23: Normal effort in double arches.

5. Conclusions

Starting from the interpretations of Leonardo's drawings, concerning the shapes and the structural organization of two proposals for the construction of the *tiburio* of the Milano Cathedral developed by Guillaume and Frommel (Guillaume, 1987), and Apollonio, Gaiani, Bertacchi and Frommel (2018), we analysed the static behaviour of these proposed solutions exploiting numerical models.

The aim of our structural study was to test the static and constructive efficiency of these hypotheses.

The two structures designed by Leonardo presents a different organization mainly in the parts connecting the pillars of the nave and the pillars of the transept (already built at the time of Leonardo's proposal) and the *tiburio* vaults distinguished into internal vault and an external vault.

In this study these vaults were considered identical in shape, size and springing section. The two structural solutions differ for the distributions of the supports.

The considerations and analysis carried out in this paper are affected by different degrees of approximation such as, primarily, the size of the different parts of the project, the dimensions of the sections and the thicknesses of arches and vaults. Dimensions were taken from the reference drawings trying to bring them back to the correct scale. The supporting elements were modelled according to recurring patterns in the design and verification of structures.

Unlike other investigations on monumental and artistic buildings, today usually oriented to the evaluation of the static behaviour of existing buildings (Lignola, Giamundo, & Cosenza, 2014; Giaccone, 2020; Giaccone, Fanelli, & Santamaria, In press; Suárez, Boothby, & González, In press) for which the necessary premise is a detailed survey of the elements that constitute it and the characterization of the materials, this study referred to two possible reconstructions of project ideas reported in sketches and drawings.

The study of the structural behaviour of the solution proposed by Leonardo da Vinci for the construction of the dome of the Milan Cathedral, in both the interpretations that we assumed, led to the conclusion that his ideas could be applied and find a minimum safety margin.

Results shows that Leonardo's intuition grasps the possibility of being built successfully from the point of view of static behaviour, confirming that his intuitions anticipated shapes and structures that after a few centuries have been made accountable for verification and analytical representation.

Some situations of strong stress have been found, partly due to the simplicity of the schemes adopted. In order to be defined with high reliability, they require more detailed investigations at local level.

About the different behaviour of the two solutions examined, given their substantial indifference as regards the vaults and their static behaviour, as first can be underlined, in both cases, the intuition of having to arrange structural elements capable of perform both the obvious task of carrying vertical loads and, more important, to counteract the horizontal thrusts produced by the vaults.

Such elements consist of double arches and masonry buttresses in the first case and double arches and exhaust arches, involving the parts adjacent to the *tiburio*, in the second case.

The second solution examined, more audacious, also captures an instance of lightness for the whole construction, exploiting at top the

knowledge on the behaviour of the arches which, at that time, was only intuitive and experimental.

REFERENCES

- Apollonio, F., Gaiani, M., Bertacchi, G., & Frommel S. (2018, Nov. 7-8). Reconstruction and structural reenacting of Leonardo's project for the tiburium of Milan cathedral. *Virtual Models and Scientific Value. Historic Studies and Virtual Models in the Age of Digital Humanities*. Talk conducted at Conference at Technische Universität, Berlin, Germany.
- Benvenuto, E. (1991). *An Introduction to the History of Structural Mechanics - Part II: Vaulted Structures and Elastic Systems*. Berlin, Germany: Springer.
- Bertolesi, E., Adam, J. M., Rinaudo, P., & Calderón, P. A. (2019). Research and practice on masonry cross vaults – A review. *Engineering Structures*, 180, 67-88. <https://doi.org/10.1016/j.engstruct.2018.10.085>
- Como, M. (2013). *Statics of Historic Masonry Constructions*. Berlin, Germany: Springer.
- Di Pasquale, S. (1996). *L'arte del costruire. Tra conoscenza e scienza*. Venezia, Italy: Marsilio.
- Giaccone, D. (2020). The peristyle of the Temple of Apollo at Syracuse: Historical hypotheses of reconstruction revisited through a finite element analysis. *Digital Applications in Archaeology and Cultural Heritage*, 16(e00138). <https://doi.org/10.1016/j.daach.2020.e00138>
- Giaccone, D., Fanelli, P., & Santamaria, U. (In press). Influence of the geometric model on the structural analysis of architectural heritage. *Journal of Cultural Heritage*. <https://doi.org/10.1016/j.culher.2019.12.001>
- Girardi, M., Padovani, C., Pellegrini, D., Porcelli, M., & Robol, L. (2020). Finite element model updating for structural applications. *Journal of Computational and Applied Mathematics*, 370(112675). <http://dx.doi.org/10.1016/j.cam.2019.112675>
- Gaetani, A., Monti, G., Lourenço, P.B., & Marcari, G. (2016). Design and Analysis of Cross Vaults Along History. *International Journal of Architectural Heritage*, 10(7), 841-856. <https://doi.org/10.1080/15583058.2015.1132020>
- Guillaume, J. (1987). Le tiburio de la cathédrale de Milan. In P. Galluzzi (Ed.). *Léonard de Vinci ingénieur et architecte* (pp. 209-223). Montréal, Canada: Musée des beaux-arts de Montréal.
- Heyman, J. (1966). The stone skeleton. *International Journal of Solids and Structures*, 2(2), 249-279. [https://doi.org/10.1016/0020-7683\(66\)90018-7](https://doi.org/10.1016/0020-7683(66)90018-7)
- Kurrer, K. E. (2008). *The history of the theory of structures: from arch analysis to computational mechanics*. Berlin, Germany: Ernst & Sohn.
- Leonardo da Vinci, (1487ca). *Codex Atlanticus*. Biblioteca Ambrosiana, Milano, Italy.
- Leonardo da Vinci, (1478-93). *Codex Trivulzianus - 2162*. Biblioteca Trivulziana, Milano, Italy.
- Leonardo da Vinci, (1488-90 ca). *Manuscript B - 2173*. Bibliothèque de l'Institut de France, Paris, France.
- Leonardo da Vinci, (1488-90 ca). *Manuscript A - 2172*, Bibliothèque de l'Institut de France, Paris, France.
- Lignola, G. P., Giamundo, V., & Cosenza, E. (2014). Finite Element Modelling of the Archaeological Colonnade in Pompeii. In B.H.V. Topping, P. Iványi, (Eds.) *Proceedings of the Twelfth International Conference on Computational Structures Technology*, (paper 77). Stirling, United Kingdom: Civil-Comp Press. <https://doi:10.4203/ccp.106.77>
- Milani, G., & Lourenço, P. B. (2007). Modelling masonry with limit analysis finite elements: Review applications and new directions. In B. H. V. Topping (Ed.), *Civil Engineering Computations: Tools and Techniques* (pp. 217-242). Stirling, United Kingdom: Saxe-Coburg Publications.

Modena, C. (2005). Design approaches of interventions for the safety and conservation of historic buildings, In C. Modena, P. B. Lourenço, P. Roca (Eds.), *Structural Analysis of Historical Constructions* (pp. 75-83). London, Great Britain: Taylor and Francis group.

Roca, P., Cervera, M., Pelà, L., Clemente, R., & Chiumenti, M. (2013). Continuum FE models for the analysis of Mallorca Cathedral. *Engineering Structures*, 46, 653-670. <http://dx.doi.org/10.1016/j.engstruct.2012.08.005>

Suárez, J., Boothby, T. E., & González, J. A. (In press). Constructive and structural analysis of a Baroque dome in Spain. The encamonada dome. *Journal of Cultural Heritage*. <https://doi.org/10.1016/j.culher.2019.12.005>

Theodossopoulos, D., Sinha, B. P., Usmani, A. S., & Macdonald, A. J. (2002). Assessment of the structural response of masonry cross vaults. *Strain*, 38(2), 119-137. <https://doi.org/10.1046/j.0039-2103.2002.00021.x>